

Article number: 20240835370DD

Description: E+G Telescope-Lear motion bearings GN 2408-35-370-DD

## Measures

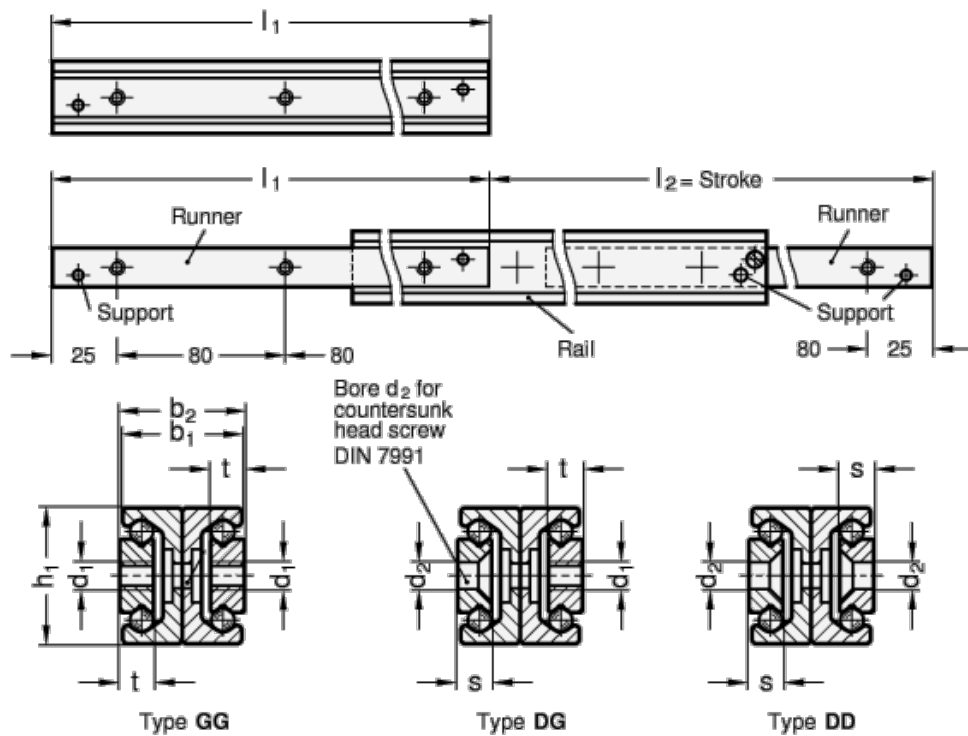

$b_1 = 33$   
 $b_2 = 34$   
 $d_1 =$   
 $d_2 = 6.5$   
 $h_1 = 35$   
 $L_1 = 370 - 406$   
 $s = 3.5$   
 $t =$

Weight in (g) = 2260